



# GEOLAM ARCHITECTURAL ELEMENTS

PROJECT:

COMPANY:

GENERAL CONTRACTOR:

ARCHITECT:

LOCATION:

**Geolam**<sup>®</sup>  
Architectural Eco-Technology



GEOLAM ARCHITECTURAL ELEMENTS

# TABLE OF CONTENTS

1. Installation Guide
2. Product Specs
3. Span Charts
4. Geolam Warranty





## INSTALLATION AND MAINTENANCE GUIDE

# Geolam Architectural Elements

Facade trim, sunshades, screens and other architectural accents

**Geolam**<sup>®</sup>

Architectural Eco-Technology

[www.geolaminc.com](http://www.geolaminc.com)

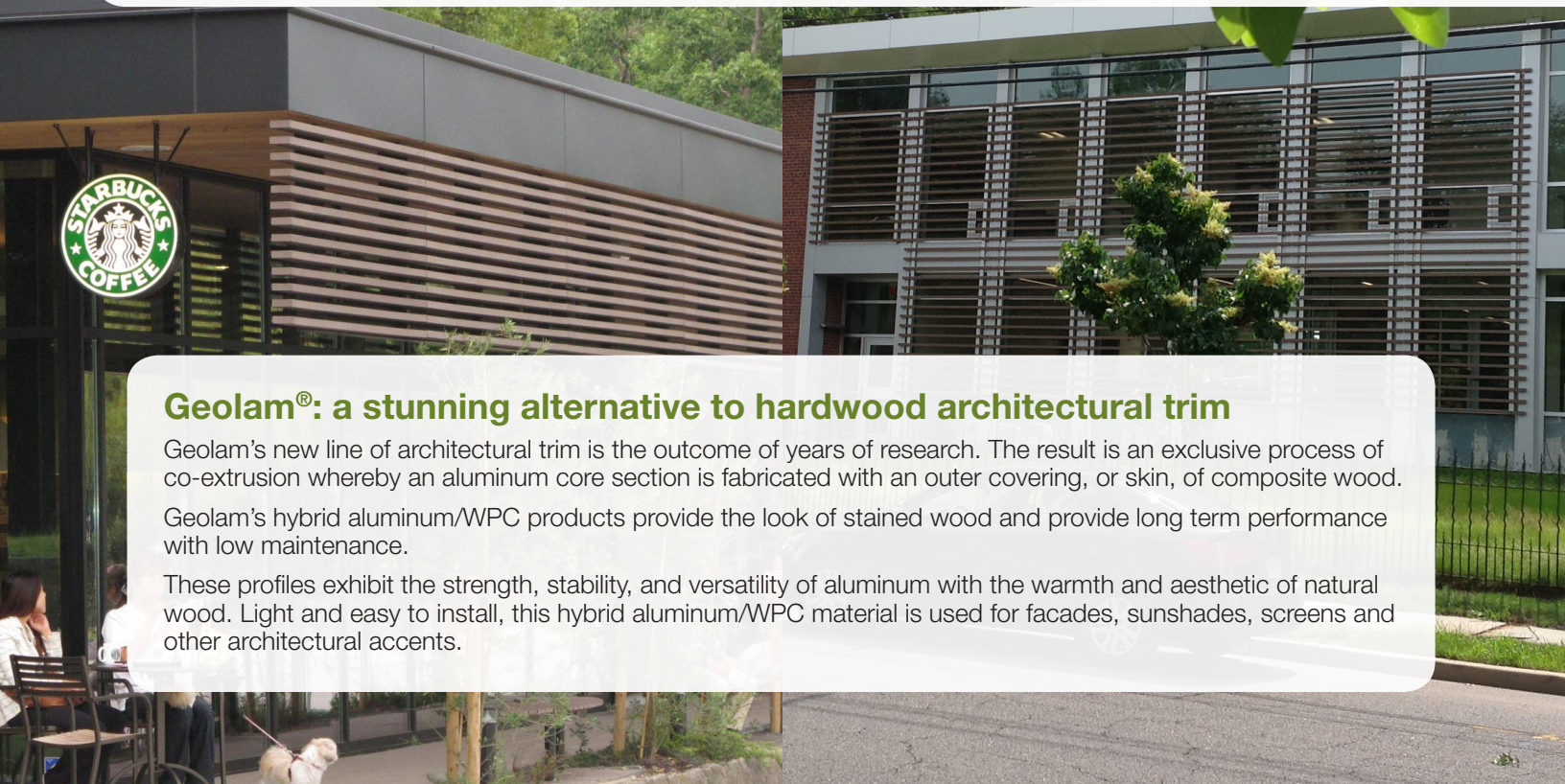

### **Geolam<sup>®</sup>: a stunning alternative to hardwood architectural trim**

Geolam's new line of architectural trim is the outcome of years of research. The result is an exclusive process of co-extrusion whereby an aluminum core section is fabricated with an outer covering, or skin, of composite wood.

Geolam's hybrid aluminum/WPC products provide the look of stained wood and provide long term performance with low maintenance.

These profiles exhibit the strength, stability, and versatility of aluminum with the warmth and aesthetic of natural wood. Light and easy to install, this hybrid aluminum/WPC material is used for facades, sunshades, screens and other architectural accents.



## CUTTING THE PROFILES

- Use motorized tools and specialized aluminum-cutting chip saws when cutting Geolam hybrid profiles.
- Do not use grinders or chainsaws for cutting.
- Not using a suitable aluminum-cutting chip saw could result in deformation, cracks and/or peeling of the product.

### Aluminium Saw Blade

Base Metal: Tool Steel

Chips: Carbide

Teeth: Minimum 2 teeth per centimeter

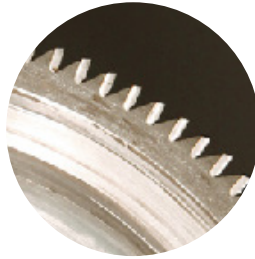

### Cutting Speed

- Maximum 2 meters per minute

### Cutting Direction

- To cut, pull the product in the same direction as the saw rotation, as shown in the illustration below.
- Cutting in the opposite direction may cause the product to move, which may produce an untidy cut in addition to being dangerous for the operator.

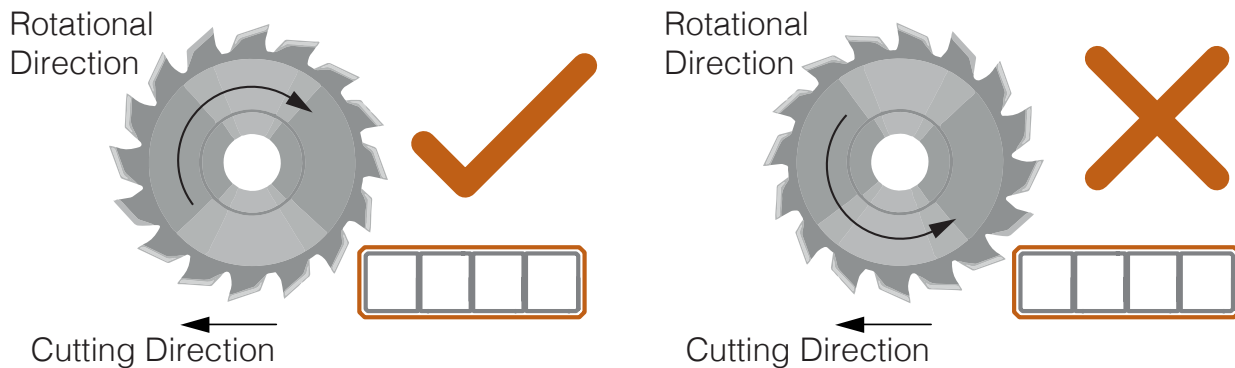



## DRILLING HOLES IN PROFILES

- Use drills for use with metal or timber and make the holes with a tabletop drilling machine or a motorized screwdriver.
- Drilling holes through both sides of the material may result in the formation of burrs or chips when the drill exits the rear side.
- Therefore, test the machine on scrap material before starting work.
- If burrs do appear, drill through from both sides independently.
- Depending on how the burrs are formed, the surface layer could be chipped to reveal the aluminum core beneath.

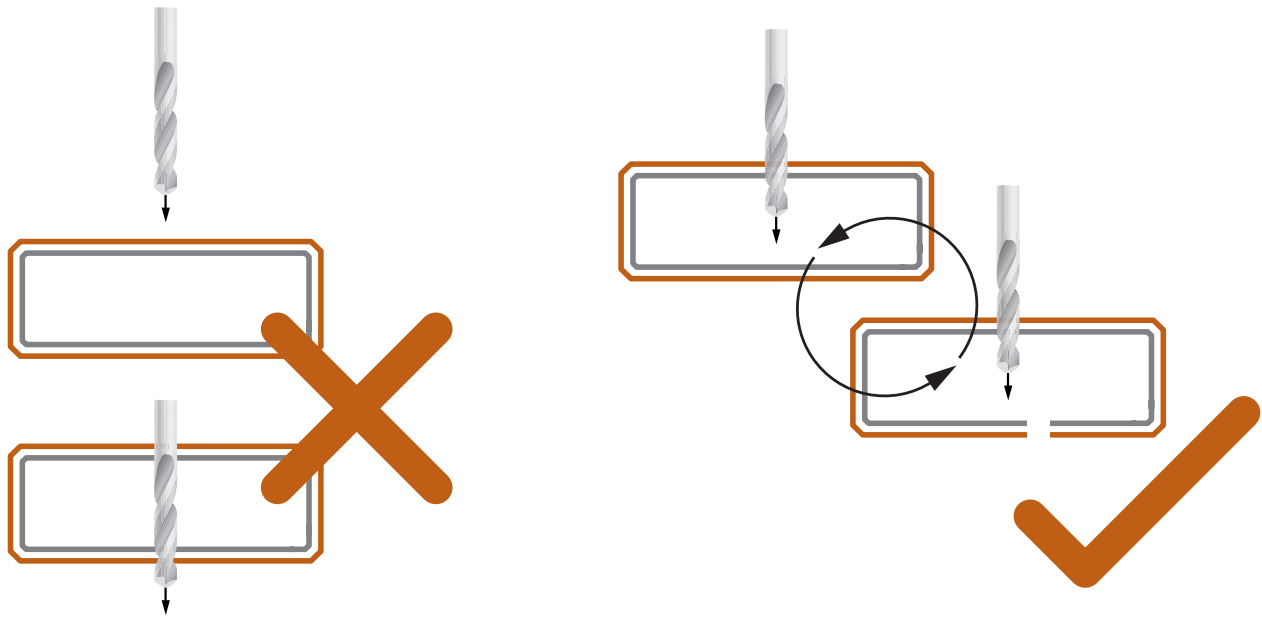



# INSTALLATION OPTIONS

## Fastening profiles using InPull nut

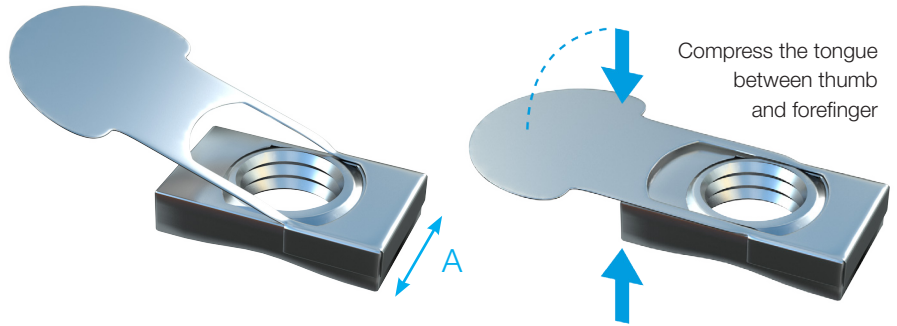

Bolt Size	Prehole Diameter (mm)	Nut Width A (mm)	Max Torque (Nm)	Max Tension Load (kN)
M6	10.2	9.5	10.0	7.8
M8	12.7	12.0	24.5	14.7
M10	15.7	14.3	39.2	19.6
M12	18.0	16.9	58.8	29.4

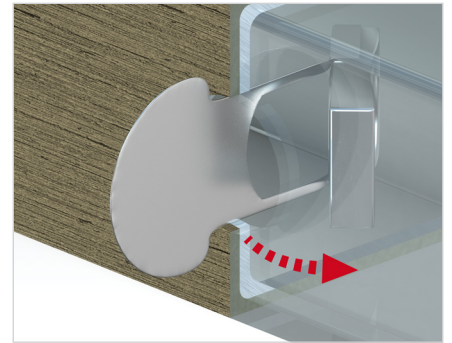
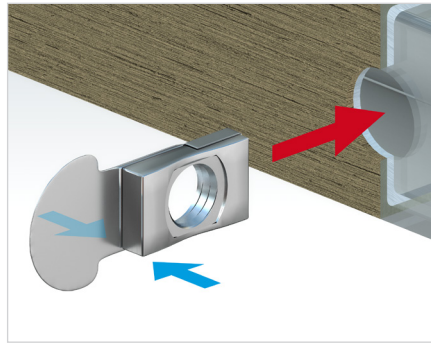
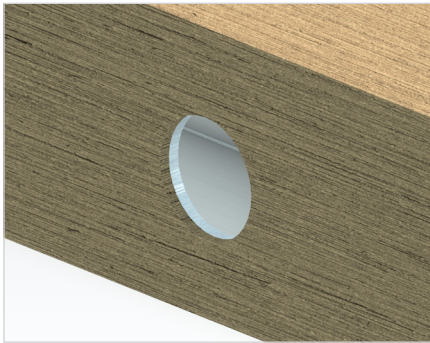

Pre-drill as shown (see above table for diameter). Select the correct InPull nut (M6 to M12) according to your fastening requirements.

Insert the InPull nut as shown. Squeeze the tongue as you insert the nut and release once the nut is in place. Once released the nut will rest at an angle to the inside of the board.

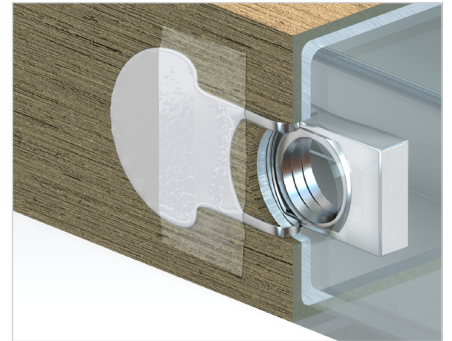
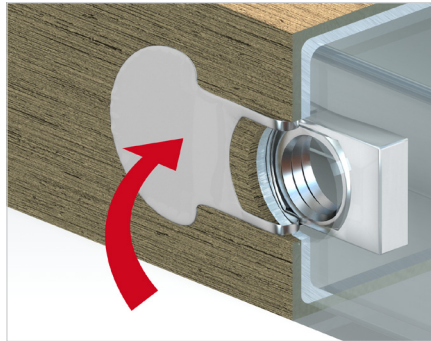
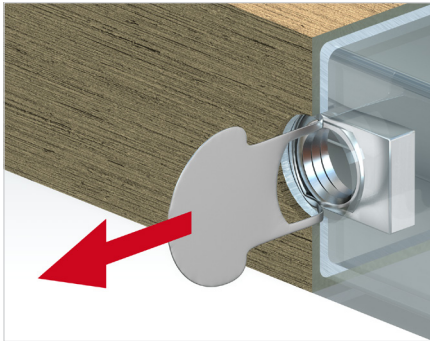

Pull out the tongue so as to secure the nut along the inside of the board.

Lay the tongue along the exterior of the board, if necessary fasten with tape to hold it.

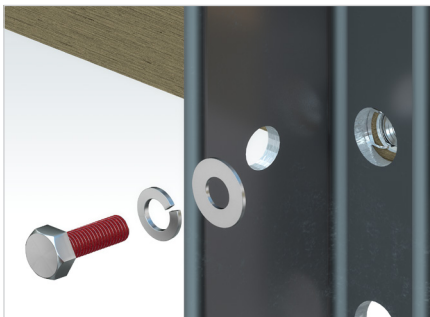

Installation of the supporting structure

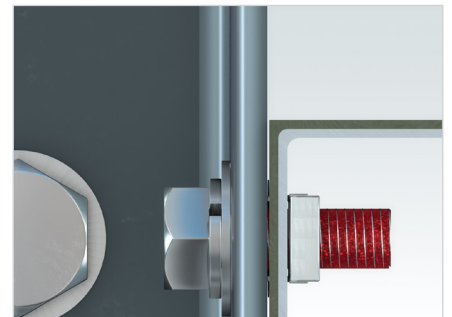

Example of assembly brackets attached with bolts and anaerobic glue e.g. "thread locker". The pre-drilled holes are wider than the bolt shaft (2 to 4 mm) to allow for expansion of the board. Washers are required as shown.



# INSTALLATION OPTIONS

## Fastening profiles using blind nut

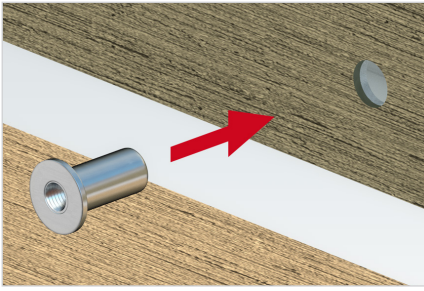

Pre-drill as shown.

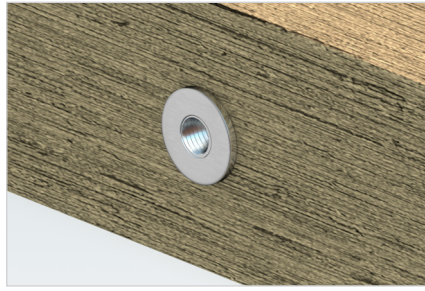

Select the correct blind nut according to your fastening requirements.

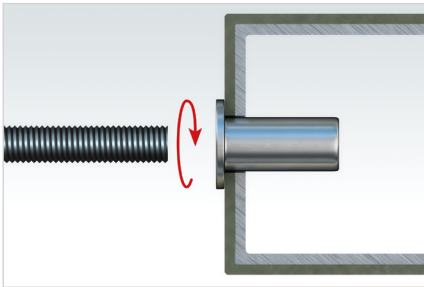

Setting the blind nuts  
(manual or pneumatic tool).

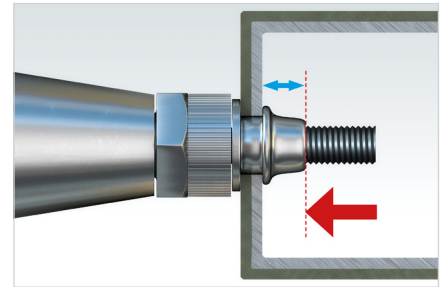
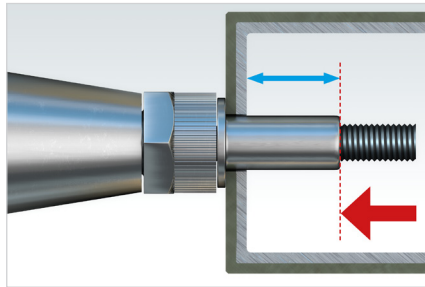

Installation of the supporting structure. The pre-drilled holes are wider (2 to 4 mm) than the bolt shaft to allow for expansion of the board. Washers are required as shown.

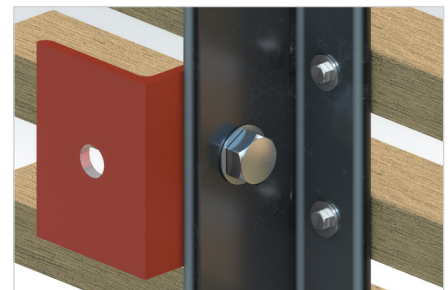
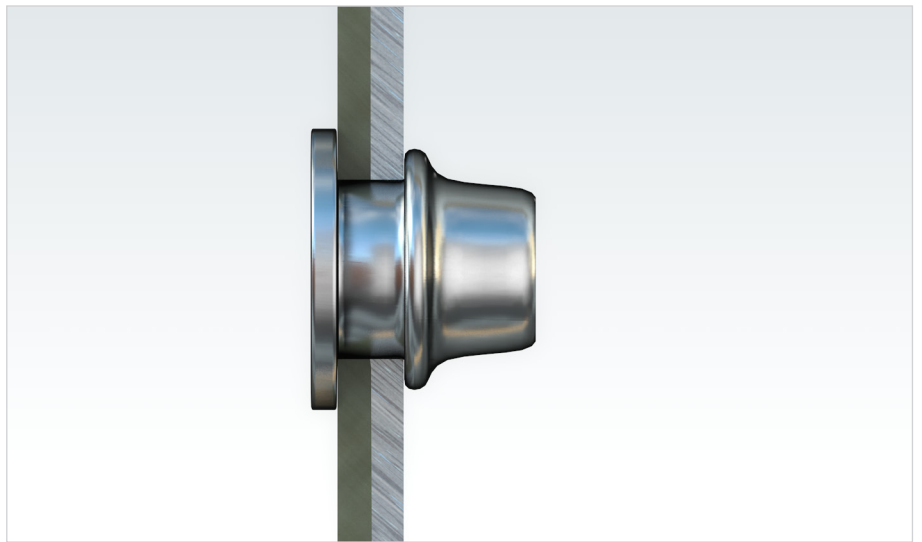



## INSTALLATION OPTIONS

### Fastening profiles using self-tapping screw



For profiles with oversized aluminum wall, a direct fastening of the profile is possible (example : Soleo 6008 installed sideways).

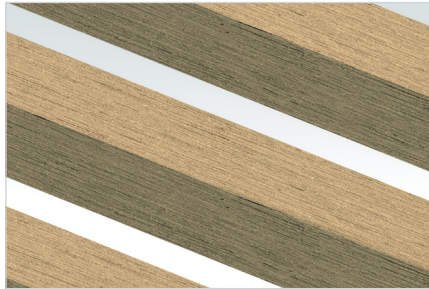

Installation of the supporting structure. The pre-drilled holes are wider (2 to 4 mm) than the bolt shaft to allow for expansion of the board. Washers are required as shown.

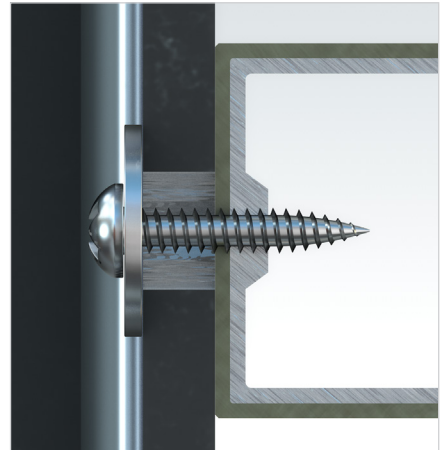
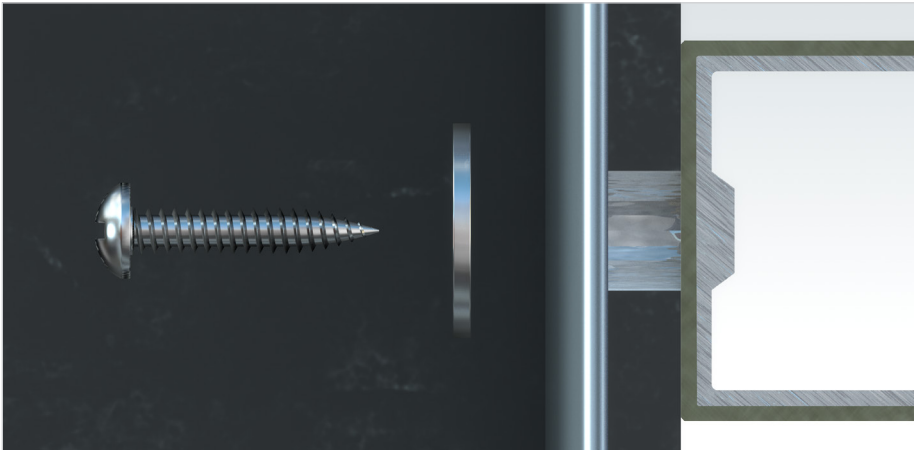

Example of assembled brackets.

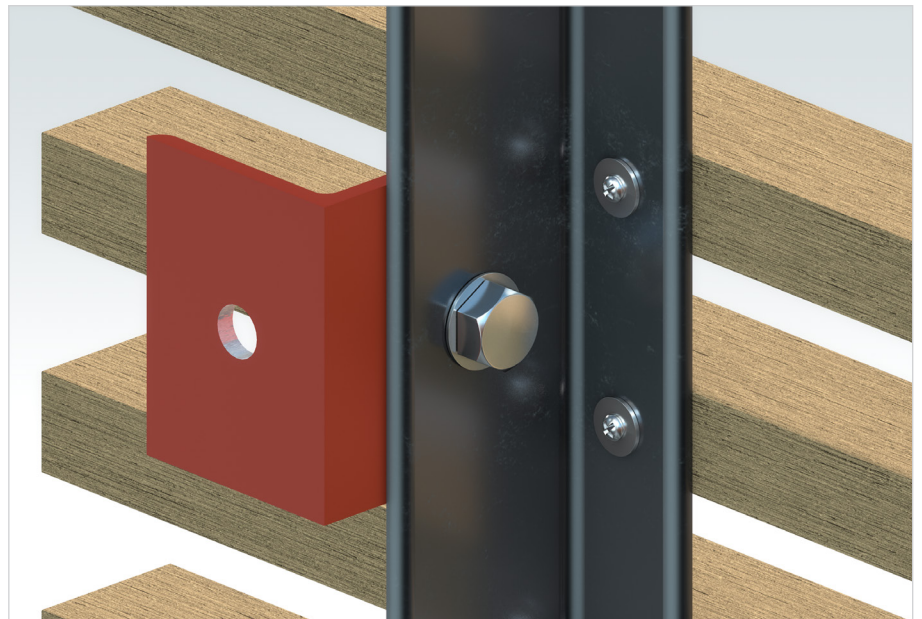
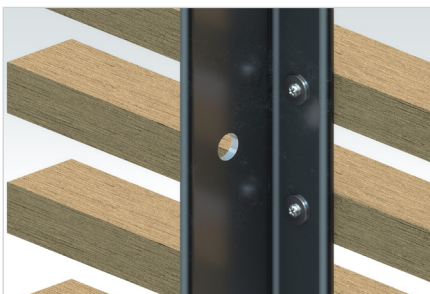

## INSTALLATION OPTIONS

### Fastening profiles using flange bolt

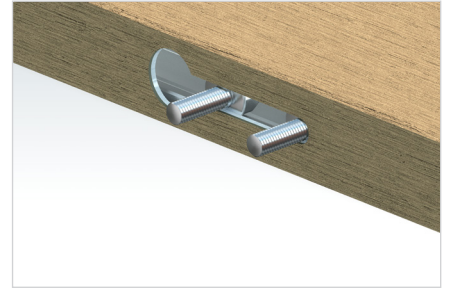
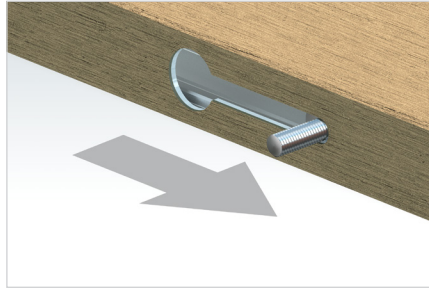
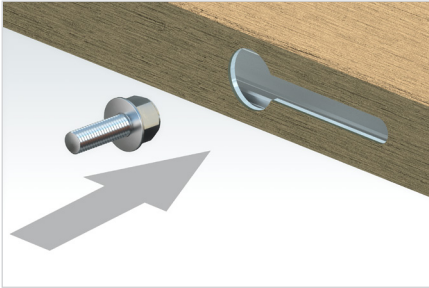

Setting up the first flange bolt.

Setting up the second flange bolt.

For specific profile only, use flange bolts allows a strong fixation (example: Soleo 6032 installed sideways).

According to the picture, drill a specific oblong hole using a numerically controlled milling machine.

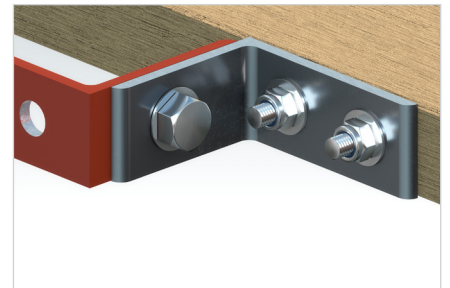
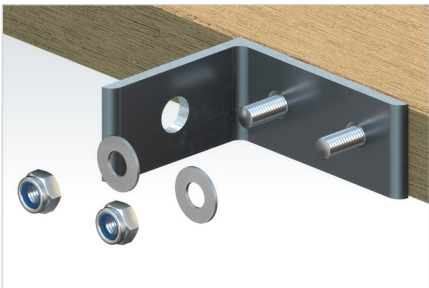
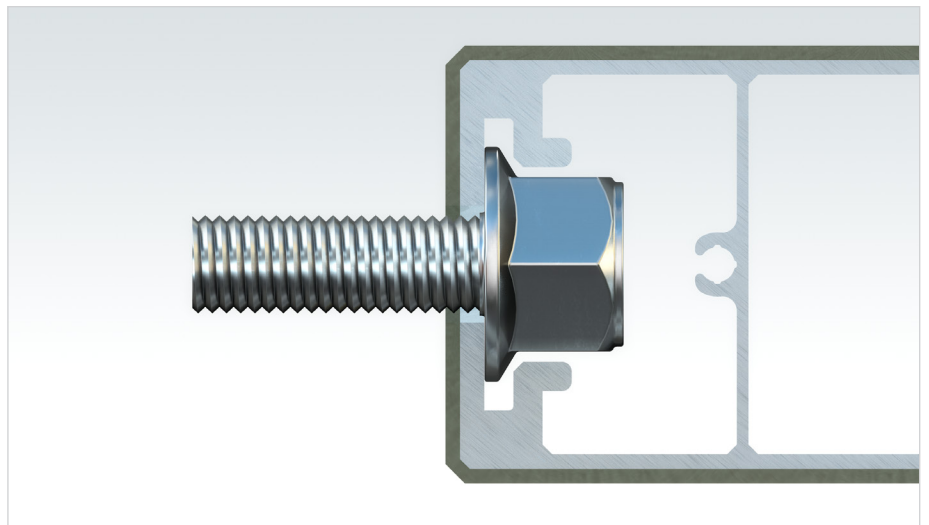

Example of fixation on assembly brackets using braked nuts.



## INSTALLATION OPTIONS cont/...

### Bolt nuts, in-pull nuts and turn nuts

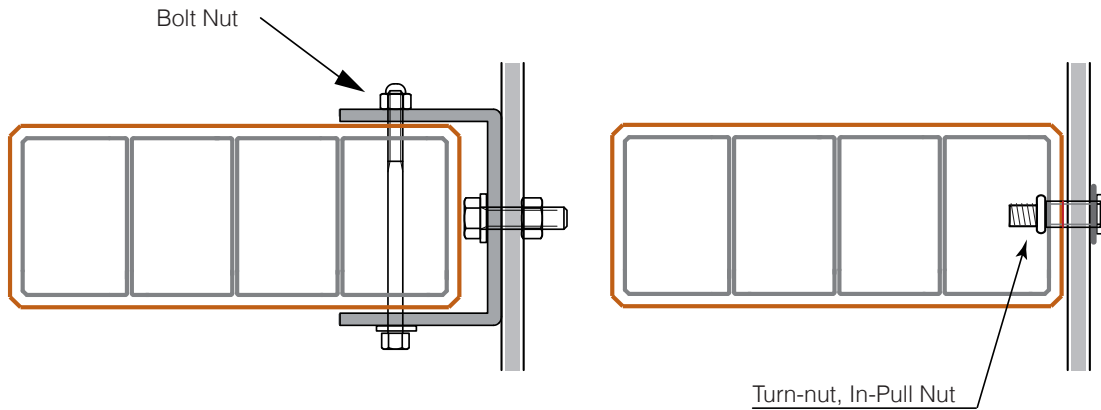

- Fix bolt-nuts, in-pull nuts, and turn-nuts firmly in place (recommended at 3.5Nm).
- Over-tightening may result in deformities, cracks and/or peeling appearing on the surface layer.
- Consult a local building code for joint span and bolt size requirement.
- Fixing the product in place with tapping screws or drill screws is not recommended.
- Nails must also not be used for fixing.
- Check the strength requirement prior to fixing to joint.

## WPC AND ASA END CAPS INSTALLATION

The end caps have to be glued to the profile. The end caps have four openings to allow for weeping of condensation – these must not be blocked or closed up. For a perfect aesthetic, wood composite end caps (WPC) can be adapted in size to the profile or showcased by an appropriate additional sanding by hand.

End caps must be glued to the WHS profile.

Use glue like Sikaflex®: Crystal Clear or 3M®: DP- 8010 :

- Designed to glue plastic (PP and PE) with Aluminum
- Moisture resistant
- Made for extreme temperature fluctuations (-30°C to + 75°C)
- Transparent

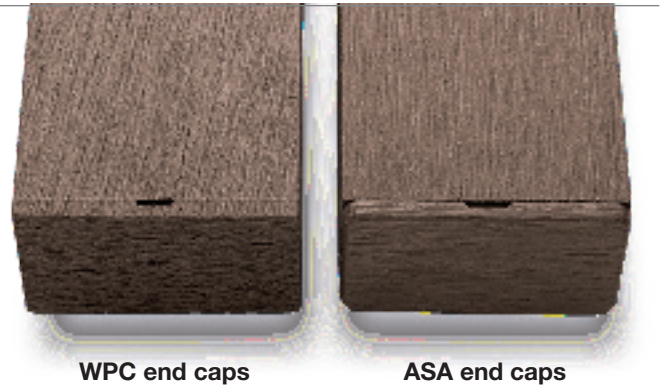

### Fix the end cap by following the 4 steps below

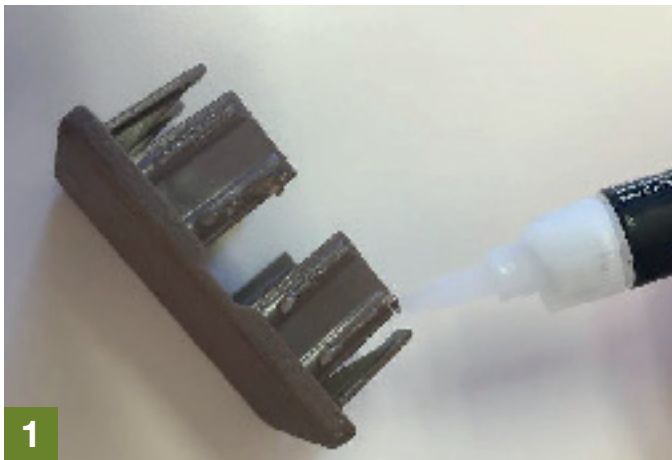

Ensure that the surfaces of the clip and the aluminum are clean. Apply one drop of quick-drying glue to each side of the end cap.



Insert the cap into the end of the WHS profile and verify that NO adhesive has come out on the sides. If so, clean quickly.



Press on the end cap with fingers and hold for about 5 seconds. Make sure that there is no gap between the WHS profile and the end cap.

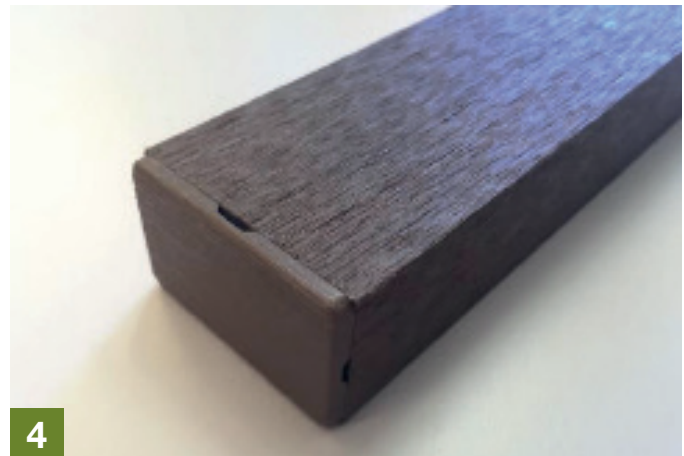

The end cap is fixed.



---

## BENDING THE PROFILES

---

- Do not bend the product in environments of 20 degrees Celsius or lower.
- Do not allow the product to reach a temperature exceeding 60 degrees Celsius.
- Do not allow oil, water or other liquids to come into contact with the work.
- Thoroughly wipe away all soiling from the bending machine before starting work.
- Do not use material that has been bent and then re-straightened.

---

## SANDING THE PROFILES

---

- All profiles are delivered facing the same direction they were sanded in.
- Mount the profiles facing the same direction in order to keep an identical aspect across all profiles.
- Or, mount profiles facing different directions in order to achieve different shades caused by sun beams reflecting from different angles.
- Refer to the marks inside the profiles that indicate the direction of sanding.

---

## POST INSTALLATION MAINTENANCE

---

- Clear away all cutting dust with an air blower, and make sure the dust does not get caught between products when they are stacked.
- Remove all post-processing burrs with sandpaper.
- Remove all soiling with a neutral detergent such as soap water.
- If a neutral detergent does not successfully remove the soiling, or when differences in luster caused by rubbing exist, use #24 to #40 sandpaper.
- Rub in a single direction (lengthwise) and finish it so that it looks the same as other surfaces.

---

## THE LINEAR THERMAL EXPANSION COEFFICIENT

---

- The linear thermal expansion coefficient for Geolam profiles is the same as for aluminium:  $2.3 \times 10^{-5}$  mm (20-100°C).
- Geolam profile expansion (per meter) = expansion coefficient x temperature difference (°C) x product length (mm).
- Thus, for a temperature difference of 40°C a Geolam profile expands by 0.92 mm per meter.

---

## STORAGE

---

- Do not position the product in an upright position but store it indoors on a flat area.
- Cover the product with a protective sheet if it must be stored outdoors to prevent contact with water.
- However, the product must not be completely sealed-in when covered with a protective sheet.

### Geolam, Inc.

North America: 9 Shorncliffe Ave., Toronto, ON Canada M4V 1S9  
Toll free: 1-877-627-3530 • Tel: 416-548-7450 • info@geolaminc.com

[www.geolaminc.com](http://www.geolaminc.com)

# TECHNICAL DATA

## Hybrid aluminum/wpc ELEMENTS

These profiles exhibit the strength, stability, and versatility of aluminum with the warmth and aesthetic of natural wood. Light and easy to install, this hybrid aluminum/wpc material is used for facade trim, sunshades, screens and other architectural accents.

### Soleo 6027

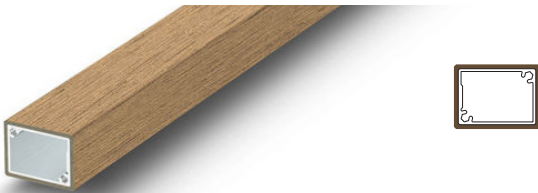

#### Soleo 6027

Dimensions	40 mm x 30 mm / 1 1/2" x 1 1/4"
Weight	0.74 kg/ml / 0.49 lb/ft
End Caps	Yes
Splices/Connectors	No

### Soleo 6008 formerly Soleo 11



#### Soleo 6008

Dimensions	52 mm x 32 mm / 2" x 1 1/4"
Weight	0.77 kg/ml / 0.52 lb/ft
End Caps	Yes
Splices/Connectors	Yes

### Soleo 6029

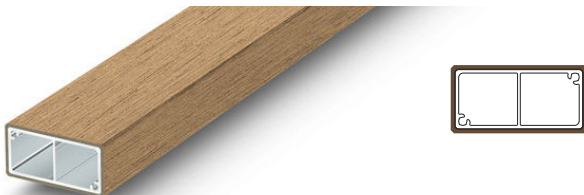

#### Soleo 6029

Dimensions	60 mm x 30 mm / 2 3/8" x 1 1/4"
Weight	1.00 kg/ml / 0.67 lb/ft
End Caps	Yes
Splices/Connectors	No

### Soleo 6026

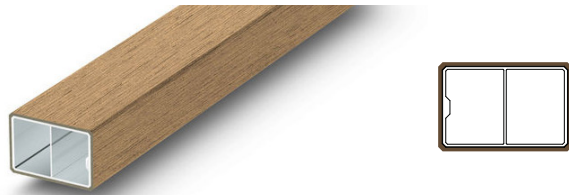

#### Soleo 6026

Dimensions	60 mm x 40 mm / 2 3/8" x 1 1/2"
Weight	1.05 kg/ml / 0.71 lb/ft
End Caps	Yes
Splices/Connectors	No



# Hybrid aluminum/wpc ELEMENTS CONTINUED

## Soleo 6011



### Soleo 6011

Dimensions	70 mm x 40 mm / 2 3/4" x 1 1/2"
Weight	1.12 kg/ml / 0.75 lb/ft
End Caps	No
Splices/Connectors	No

## Soleo 6030

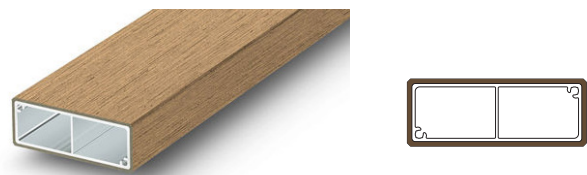

### Soleo 6030

Dimensions	80 mm x 30 mm / 3 1/8" x 1 1/4"
Weight	1.20 kg/ml / 0.80 lb/ft
End Caps	Yes
Splices/Connectors	No

## Soleo 6017



### Soleo 6017

Dimensions	93 mm x 43 mm / 3 5/8" x 1 5/8"
Weight	1.60 kg/ml / 1.08 lb/ft
End Caps	Yes
Splices/Connectors	No

## Soleo 6036

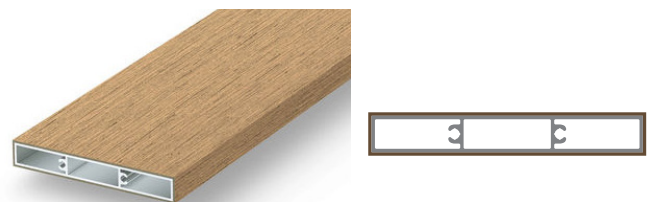

### Soleo 6036

Dimensions	100 mm x 15 mm / 4" x 5/8"
Weight	1.00 kg/ml / 0.67 lb/ft
End Caps	No
Splices/Connectors	No

## Soleo 6009



### Soleo 6009

Dimensions	100 mm x 30 mm / 4" x 1 1/4"
Weight	1.40 kg/ml / 0.94 lb/ft
End Caps	Yes
Splices/Connectors	No

## Soleo 6034



### Soleo 6034

Dimensions	105 mm x 53 mm / 4 1/8" x 2"
Weight	1.94 kg/ml / 1.30 lb/ft
End Caps	Yes
Splices/Connectors	No

# Hybrid aluminum/wpc ELEMENTS CONTINUED

## Soleo 6031 formerly Soleo 1263



### Soleo 6031

Dimensions	126 mm x 28 mm / 5" x 1 1/8"
Weight	1.75 kg/ml / 1.16 lb/ft
End Caps	Yes
Splices/Connectors	Yes

## Soleo 6010 formerly Soleo 10



### Soleo 6010

Dimensions	128 mm x 53 mm / 5" x 2"
Weight	2.30 kg/ml / 1.55 lb/ft
End Caps	Yes
Splices/Connectors	Yes

## Soleo 6038



### Soleo 6038

Dimensions	145 mm x 22 mm / 5 3/4" x 7/8"
Weight	2.00 kg/ml / 1.34 lb/ft
End Caps	No
Splices/Connectors	No

## Soleo 6044

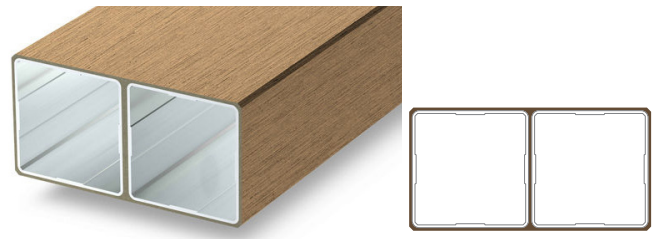

### Soleo 6044

Dimensions	174 mm x 87 mm / 6 7/8" x 3 1/2"
Weight	4.52 kg/ml / 3.04 lb/ft
End Caps	No
Splices/Connectors	No

## Soleo 6033

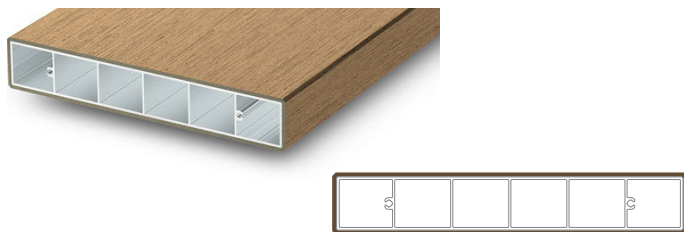

### Soleo 6033

Dimensions	200 mm x 35 mm / 7 7/8" x 1 3/8"
Weight	3.30 kg/ml / 2.22 lb/ft
End Caps	Yes
Splices/Connectors	No

## Soleo 6072



### Soleo 6072

Dimensions	200 mm x 50 mm / 7 7/8" x 2"
Weight	3.93 kg/ml / 2.64 lb/ft
End Caps	No
Splices/Connectors	No



# Hybrid aluminum/wpc ELEMENTS CONTINUED

## Soleo 6042

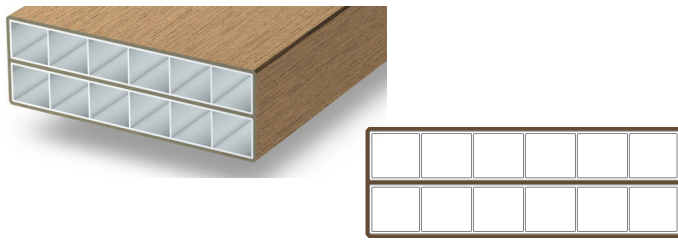

### Soleo 6042

Dimensions	200 mm x 70 mm / 7 7/8" x 2 3/4"
Weight	8.40 kg/ml / 5.65 lb/ft
End Caps	No
Splices/Connectors	No

## Soleo 6045

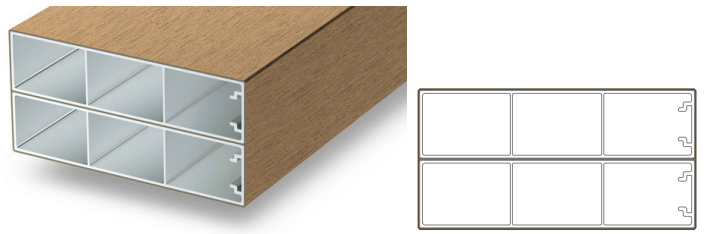

### Soleo 6045

Dimensions	200 mm x 100 mm / 7 7/8" x 4"
Weight	7.86 kg/ml / 5.28 lb/ft
End Caps	No
Splices/Connectors	No

## Soleo 6041

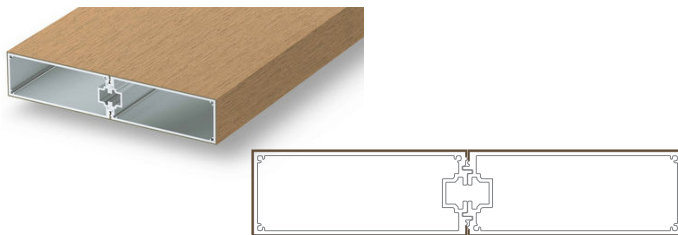

### Soleo 6041

Dimensions	300 mm x 60 mm / 11 3/4" x 2 3/8"
Weight	7.80 kg/ml / 5.24 lb/ft
End Caps	No
Splices/Connectors	No

## Soleo 6043

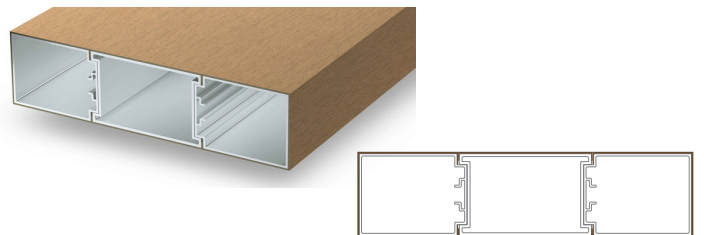

### Soleo 6043

Dimensions	300 mm x 75 mm / 11 3/4" x 3"
Weight	6.80 kg/ml / 4.57 lb/ft
End Caps	No
Splices/Connectors	No

## Soleo 6046

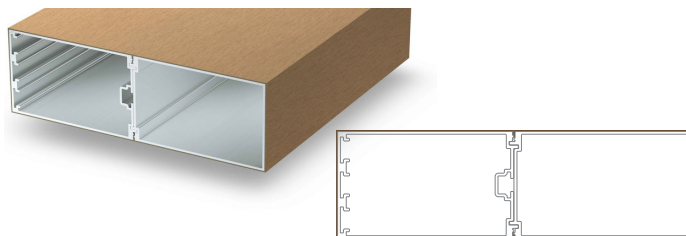

### Soleo 6046

Dimensions	350 mm x 110 mm / 13 3/4" x 4 1/4"
Weight	9.90 kg/ml / 6.65 lb/ft
End Caps	No
Splices/Connectors	No

## Planeo 4010



### Planeo 4010

Dimensions	145 mm x 30 mm / 5 3/4" x 1 1/4"
Weight	1.95 kg/ml / 1.31 lb/ft
End Caps	No
Splices/Connectors	No

# Hybrid aluminum/wpc ELEMENTS CONTINUED

## Diameo 6018



### Diameo 6018

Dimensions	120 mm x 30 mm / 4 3/4" x 1 1/4"
Weight	1.68 kg/ml / 1.13 lb/ft
End Caps	Yes
Splices/Connectors	Yes

## Diameo 6037

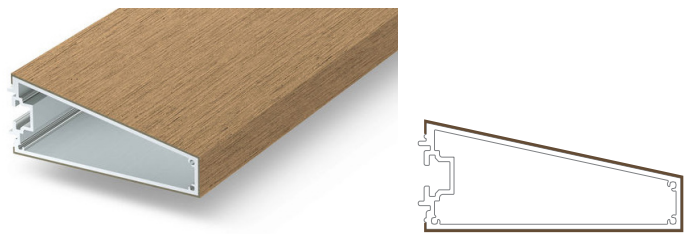

### Diameo 6037

Dimensions	150 mm x 60 mm / 5 7/8" x 2 1/2"
Weight	3.71 kg/ml / 2.49 lb/ft
End Caps	No
Splices/Connectors	No

## Diameo 6022

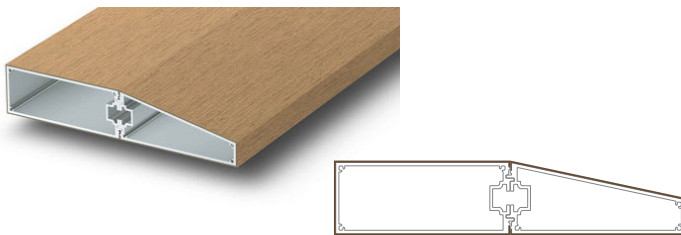

### Diameo 6022

Dimensions	300 mm x 60 mm / 11 3/4" x 2 1/2"
Weight	7.61 kg/ml / 5.11 lb/ft
End Caps	No
Splices/Connectors	No

## Diameo 6023

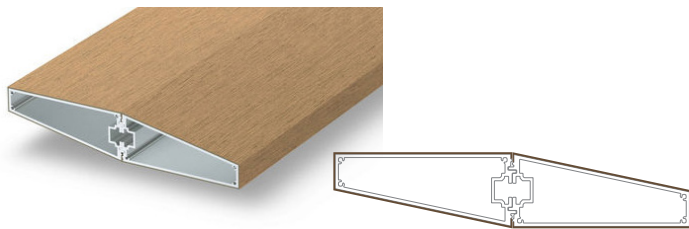

### Diameo 6023

Dimensions	300 mm x 60 mm / 11 3/4" x 2 1/2"
Weight	7.42 kg/ml / 4.99 lb/ft
End Caps	No
Splices/Connectors	No

## Rondo 3002



### Rondo 3002

Dimensions	Diameter 50 mm / Diameter 2"
Weight	0.95 kg/ml / 0.64 lb/ft
End Caps	No
Splices/Connectors	No

## Rondo 3003



### Rondo 3003

Dimensions	Diameter 56 mm / Diameter 2 3/8"
Weight	1.07 kg/ml / 0.72 lb/ft
End Caps	No
Splices/Connectors	No

# Hybrid aluminum/wpc ELEMENTS CONTINUED

## Rondo 3004

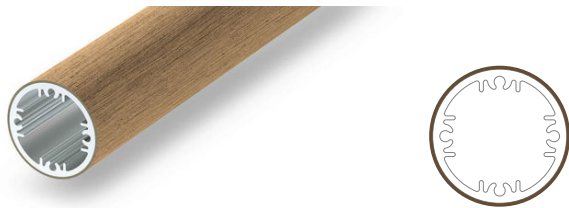

Rondo 3004	
Dimensions	Diameter 63 mm / Diameter 2 1/2"
Weight	2.46 kg/ml / 1.65 lb/ft
End Caps	No
Splices/Connectors	No

## Careo 7015



Careo 7015	
Dimensions	45 mm x 45 mm / 1 3/4" x 1 3/4"
Weight	0.70 kg/ml / 0.47 lb/ft
End Caps	No
Splices/Connectors	No

## Careo 7031



Careo 7031	
Dimensions	45 mm x 45 mm / 1 3/4" x 1 3/4"
Weight	0.82 kg/ml / 0.55 lb/ft
End Caps	No
Splices/Connectors	No

## Careo 7011



Careo 7011	
Dimensions	53 mm x 53 mm / 2" x 2"
Weight	1.25 kg/ml / 0.84 lb/ft
End Caps	No
Splices/Connectors	Yes

## Careo 7035



Careo 7035	
Dimensions	87 mm x 87 mm / 3 1/2" x 3 1/2"
Weight	2.28 kg/ml / 1.53 lb/ft
End Caps	No
Splices/Connectors	No

## Careo 7014 formerly Careo 6014

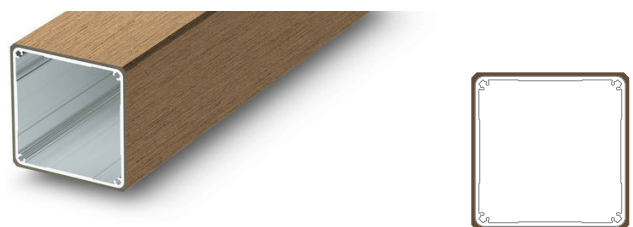

Careo 6014	
Dimensions	88 mm x 88 mm / 3 1/2" x 3 1/2"
Weight	2.7 kg/ml / 1.81 lb/ft
End Caps	Yes
Splices/Connectors	No



# Hybrid aluminum/wpc ELEMENTS CONTINUED

## Careo 7016



### Careo 7016

Dimensions	120 mm x 120 mm / 4 3/4" x 4 3/4"
Weight	4.00 kg/ml / 2.69 lb/ft
End Caps	No
Splices/Connectors	No

## Ellipso 3000



### Ellipso 3000

Dimensions	100 mm x 70 mm / 4 1/4" x 2 3/4"
Weight	N/A
End Caps	No
Splices/Connectors	No

# END CAPS Hybrid aluminum/wpc



The end caps have to be glued to the profile.  
They have four openings to allow for weeping of condensation – these must not be blocked.  
For a perfect aesthetic, wood composite end caps (WPC) can be adapted in size to the profile or showcased by an appropriate sanding.

# SPLICERS/CONNECTORS Hybrid aluminum/wpc

## Corners



## Straight

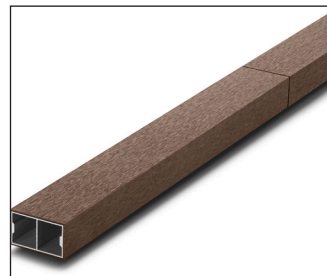
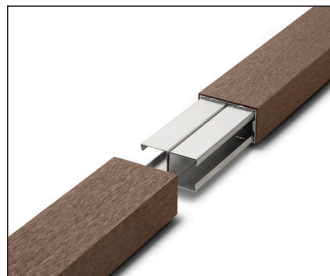
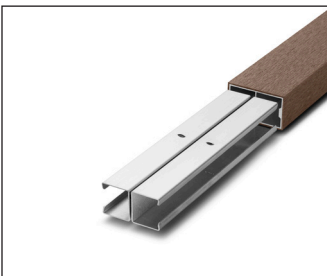

# Hybrid aluminum/wpc

## RECOMMENDED SPAN CHART\*

Profile name	Dimensions (mm/inches)	VERTICAL INSTALLATION		HORIZONTAL INSTALLATION	
		Span (m/ft)	Cantilever (m/ft)	Span (m/ft)	Cantilever (m/ft)
<b>Soleo 6031</b>	28 x 126 1.10236" x 4.96063"	3.0 9.84252	0.5 1.64042'	2.0 6.56168'	0.4 1.31234"
<b>Soleo 6027</b>	30 x 40 1.18110" x 1.5748"	1.5 4.92126'	0.3 .98245'	1.5 4.9126'	0.3 .98425'
<b>Soleo 6029</b>	30 x 60 1.96850 round	2.2 5.24934'	0.4 1.31234'	2.1 5.24934'	0.4 1.31234'
<b>Soleo 6030</b>	30 x 80 1.1810 x 3.14961	2.8 9.18635'	0.5 1.64042'	2.1 6.88976'	0.4 1.31234'
<b>Soleo 6008</b>	32 x 52 1.25984 x 2.04724	2.0 6.56128'	0.3 .98245'	2.0 6.56168'	0.3 .98425'
<b>Soleo 6012</b>	33 x 103 1.29921 x 4.05112	3.0 9.84252'	0.5 1.64042'	2.0 6.56168'	0.4 1.31234'
<b>Soleo 6033</b>	35 x 200 1.37795 x 7.87402	3.0 9.84252'	0.5 1.64042'	2.0 6.56168'	0.4 1.31234'
<b>Soleo 6026</b>	40 x 60 1.57480 x 2.36220	2.1 6.88976'	0.4 1.31234'	2.1 6.88976'	0.4 1.31234'
<b>Soleo 6017</b>	43 x 93 1.69291 x 3.66142	3.0 9.84252'	0.5 1.64042'	2.1 6.88976'	0.4 1.31234'
<b>Soleo 6034</b>	53 x 105 2.08661 x 4.13886	3.0 9.84252'	0.5 1.64042'	2.8 9.18635'	0.5 1.64042'
<b>Soleo 6010</b>	53 x 128 2.08661 x 5.0397	3.0 9.84252'	0.5 1.64042'	2.8 9.18635'	0.5 1.64042'
<b>Diameo 6018</b>	30 x 120 1.18110 x 4.72441	2.0 6.56128'	0.4 1.31234'	2.0 6.56168'	0.4 1.31234'
<b>Careo 6011</b>	53 x 53 2.08661 x 2.08661	3.0 9.84252'	0.5 1.64042'	2.8 9.18635'	0.5 1.64042'
<b>Careo 6014</b>	88 x 88 3.46454 x 3.46454	3.0 9.84252'	0.5 1.64042'	3.0 9.18635'	0.5 1.64042'
<b>Rondo 6019</b>	diam. 50 1.96850 round	1.6 5.24934'	0.4 1.31234'	1.6 5.24934'	0.4 1.31234'

\*Always check local building regulations before installing Geolam. Make sure that every profile is supported by at least 3 fixation points.



## 10-YEAR LIMITED WARRANTY

### Extent of coverage:

This warranty is given to the original Purchaser of GEOLAM<sup>®</sup> wood plastic composite decking and/or cladding boards and/or hybrid aluminum/wpc boards. This warranty does not extend to fasteners that are not supplied by the boards' manufacturer.

Geolam, Inc. guarantees the Purchaser that, for a period of ten (10) years (the term) from the date of the original purchase, under normal use and service conditions, the GEOLAM<sup>®</sup> decking and/or cladding boards and/or hybrid aluminum/wpc boards be free from material defects in workmanship and materials, and will not split, splinter, rot or suffer structural damage from termites or fungal decay.

If such a defect appears during the term, Geolam, Inc. will, at its option, supply replacement product (but not the labour cost, freight, taxes or other expenses associated with de-installation and reinstallation) or refund the purchase in an amount not to exceed Manufacturer's cost of material.

### How To File A Warranty Claim:

Purchaser must notify Geolam, Inc. in writing within thirty (30) days after the appearance of the defect, but no later than the end of the Term.

Purchaser shall send a brief written explanation of the defect, along with dated proof of purchase to Geolam, Inc., 9 Shorncliffe Avenue, Toronto, ON, M4V 1S9. Manufacturer reserves the right to request additional information, including, but not limited to, photos, and to conduct a field inspection.

### Exclusion of limited warranty:

This limited Warranty does not cover product failure, product malfunction or any damages resulting from:

- (a) improper installation of GEOLAM<sup>®</sup> products and/or failure to comply with Geolam, Inc.'s installation instructions
- (b) beyond normal use, or in an application not recommended by Geolam, Inc.'s installation instructions and local building codes;
- (c) movement, distortion, collapse or settling of the ground or the supporting structure on which GEOLAM<sup>®</sup> products are installed;
- (d) any act of God (such as flooding, hurricane, earthquake, lightning, etc.), environmental condition (such as air pollution), or staining from foreign substances (such as dirt, grease, oil, etc.);
- (e) variations or changes in color of GEOLAM<sup>®</sup> products;
- (f) normal weathering due to exposure to sunlight, moisture, and atmosphere, and accumulation of dirt or stains;
- (g) damages of any kind caused by animals, domestic or otherwise;
- (h) improper handling, storage, abuse or neglect of GEOLAM<sup>®</sup> products by Purchaser, or third parties;
- (i) any fasteners not supplied by Geolam, Inc.; and

Failure to strictly adhere to Manufacturer's written instruction manual for the installation, use or maintenance of GEOLAM<sup>®</sup> will render this Limited Warranty null and void.

### Limitations of remedies and exclusion of consequential and incidental damages

To the extent permitted by law, Geolam, Inc.'s liabilities are limited solely and exclusively to the obligations specifically specified herein and under no circumstances will Geolam, Inc. be liable or obligated for any incidental, consequential, indirect, special, punitive or any other damages of any kind whatsoever.

This writing is understood and intended to be the final expression of the parties' agreement and is **a complete and exclusive statement** of the terms and conditions with respect thereto, superseding all prior agreements or representations, oral or written, and all other communication between the parties relating to the subject matter of this agreement. No agent, employee or any other party is authorized to make any warranty on behalf of Geolam, Inc. in addition to that made in this agreement.

***This warranty is effective for purchases made on or after May 1, 2011.***